



**HIGH
RATE
MAX^{XT}**



UPS12-490MRX

Valve Regulated Lead Acid Battery

Designed for UPS Standby Power Applications

FEATURES AND BENEFITS

APPLICATIONS

- Data Centers
- Network Operation Centers
- Industrial Process Control Facilities
- Internet Housing Sites
- Semiconductor Manufacturing
- Banks and Financial Markets
- Power Generation Plants
- Hospital and Testing Laboratories
- Emergency Response Center

- 12 year design life @ 25°C
- Eurobat classification: Long life
- Absorbent Glass Mat (AGM) technology for efficient gas recombination of up to 99% and freedom from electrolyte maintenance.
- 3 Year Warranty (refer Dynasty warranty card, 41-9027)
- Patented Long Life Alloy having the lowest calcium levels in the industry - minimizing grid growth, reducing gassing, and extending battery life
- Patented UL Recognized Flame-arresting vents in each cell for safety and long life.
- Designed with the same recombination, thermal runaway prevention, gassing and flame retardant characteristics of the Bellcore 4228 compliant Dynasty Telecom products.
- Flame retardant polypropylene case and cover compliant with UL94V-2
- Proprietary Fixed Orifice Plate Pasting technology applying active materials on both sides of the grid for consistent cell-to-cell performance, higher capacity and uniform grid protection.
- Thermally welded case-to-cover bond to eliminate leakage
- Can be operated in upright, side or end mounting orientation.
- Not restricted for air transport -Complies with IATA/ICAO Special Provisions A67.
- Not restricted for surface transport - Classified as non-hazardous material as related to DOT-CFR Title 49 parts171-189
- Not restricted for water transport - Classified as non-hazardous material per IMDG Amendment 27.

Specifications

Cells Per Unit	Voltage Per Unit	Weight	Watts/Cell @ 15min	1 Min Current to 1.75VPC	IEC Short Circuit Current	IEC Resistance
6	12V	46.6 Kg	490	599 Amps	3160 Amps	3.96 (mOhms)

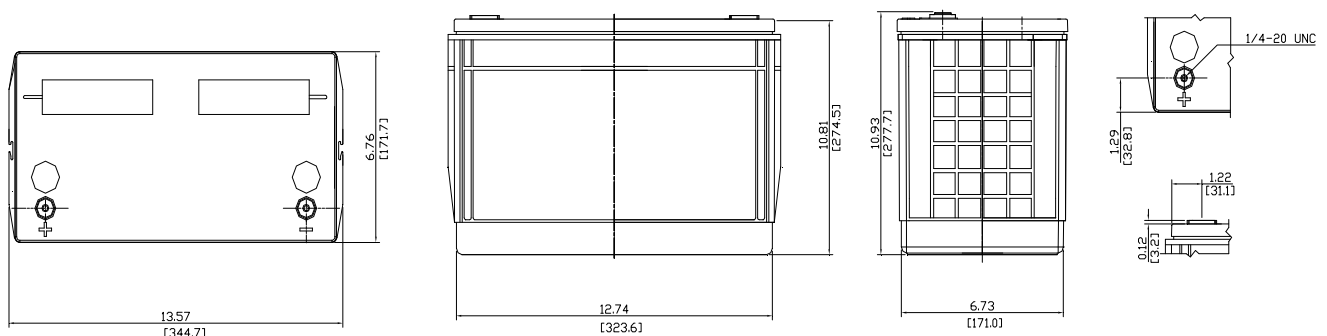

*All dimensions in inches and (millimeters). All dimensions are for reference only. Contact a C&D Representative for complete dimensional information.

Specifications

Operating Temperature Range with temperature compensation	Discharge: -40° F (-40° C) to +160°F (71°C) Charge: -10°F (-23°C) to +140°F (60°C)
Nominal Operating Temperature Range	+74° F (23°C) to +80°F (27°C)
Recommended Maximum Charging Current Limit	C/5 amperes @ 20hr rate
Float Charging Voltage	13.65 ± 0.15 VDC average per 12V unit
Maximum AC Ripple (Charger)	0.5% RMS or 1.5% P-P of float charge voltage recommended for best results. Max voltage allowed = 1.4% RMS (4% P-P) Max current allowed = C/20
Self Discharge	Battery can be stored up to 6 months at 77° F (25°C) before a freshening charge is required. Batteries stored at temperatures greater than 77°F (25°C) will require recharge sooner than batteries stored at lower temperatures. See C&D brochure 41-7272, Self-Discharge and Inventory Control for details.
Equalize charge and cycle service voltage	14.40 to 14.80 VDC average per 12V unit @ 77° F (25°C)
Terminal	Threaded copper alloy insert terminal to accept 1/4-20 UNC bolt
Terminal Hardware Initial Torque	110 in.-lbs. (12.4 N-m)

Constant Power Discharge Table - Watts Per Cell @ 25°C (77°F)

Operating Time to End Point Voltage

EPV	5 min	10 min	15 min	20 min	25 min	30 min	45 min	60 min	90 min	2 hr	3 hr	4 hr	5 hr	8 hr	10 hr	12 hr	20 hr
1.85	545.6	447.3	372.8	323.0	288.9	263.8	208.2	176.0	129.4	104.0	73.8	57.9	48.1	32.1	26.5	22.7	14.6
1.80	641.0	520.5	421.8	359.0	316.8	286.1	222.4	186.0	136.8	110.0	77.8	60.7	50.0	33.3	27.5	23.5	15.1
1.75	695.0	560.6	449.5	379.0	332.0	298.0	229.0	190.0	138.5	110.7	78.2	61.7	50.9	33.8	27.9	23.8	15.3
1.70	752.8	602.9	478.9	400.3	348.2	310.8	235.9	194.0	140.1	111.2	78.6	61.4	50.8	34.0	28.1	24.0	15.5
1.67	794.3	624.0	494.9	411.4	356.4	317.0	238.6	195.0	140.7	111.6	78.9	61.7	50.9	34.1	28.1	24.1	15.5
1.65	825.2	643.2	505.8	419.0	362.0	321.3	240.6	196.0	141.2	111.9	79.1	61.8	51.1	34.1	28.2	24.1	15.6

Constant Current Discharge Table - Amps @ 25°C (77°F)

Operating Time to End Point Voltage

EPV	5 min	10 min	15 min	30 min	60 min	90 min	2 hr	3 hr	4 hr	5 hr	6 hr	7 hr	8 hr	10 hr	12 hr	20 hr	24 hr
1.90	214.2	212.4	188.8	131.0	80.0	58.2	46.4	33.4	26.4	22.0	19.1	16.7	14.8	12.0	10.2	6.4	5.4
1.85	295.0	269.1	220.2	147.6	91.5	65.5	51.6	36.9	29.1	24.2	21.0	18.4	16.3	13.3	11.3	7.1	6.0
1.80	383.7	312.2	249.6	160.0	97.2	69.2	54.4	38.7	30.4	25.2	21.8	19.1	16.9	13.8	11.7	7.3	6.2
1.75	422.3	334.0	266.5	166.3	98.5	70.0	55.0	39.4	31.2	25.8	22.3	19.6	17.3	14.1	11.9	7.5	6.3

Note: Batteries to be mounted with 0.5 in. (1.25 cm) spacing minimum and free air ventilation. Specifications subject to change without notification.